

# **VITARA**

## **Instruction Manual**

**Models: VBWC5401S**

**VBWC5201D**

# TABLE OF CONTENTS

<b>Important Safety Information .....</b>	<b>3-5</b>
<b>Installation Instructions .....</b>	<b>6-9</b>
Sizes and Installation Dimensions.....	6-7
Leveling Your Unit .....	8
Installation of the Handle .....	9
How to put off the shelves .....	9
Reversing the Door Swing.....	10
<b>Operation Instructions .....</b>	<b>11-15</b>
For Model: VBWC5401S .....	11-12
For Model: VBWC5201D.....	13-15
<b>Changing the Carbon Air Purification Filter .....</b>	<b>16</b>
<b>Care and Maintenance .....</b>	<b>17</b>
<b>Problems with Your Appliance.....</b>	<b>18</b>

# DEAR INSTALLER THE JOB ISN'T DONE UNTIL

To ensure that the installation process is successfully completed, here are few things to review...

- Is the unit plugged in?
- Are the controls on? (Panel will illuminate.)
- Are the controls operating correctly?
- Has the unit been properly leveled - both side to side and front to back – with all 4 leveling feet securely making contact with the floor?
- After installation, does the door open sufficiently to fully extend the shelves?
- Is the door sealing properly?
- Is the handle secure?
- Have you thoroughly inspected the stainless steel surfaces for any imperfections?
- Have you reviewed this manual with the customer and explained the unit's operation and care?
- Has the customer received copies of the literature and keys?
- Have you properly disposed of all packing materials properly (recycle, please)?
- Is the customer satisfied?

## **DANGER**

### **RISK OF CHILD ENTRAPMENT!**

An empty refrigerator is a very dangerous attraction to children.

Remove door gaskets, latches, lids, lock and/or doors from unused or discarded appliances,  
or take other actions to guarantee them harmless.

Always dispose of old appliances in accordance with local laws and regulations.

# YOUR SAFETY MATTERS

## Please read through completely before using your Unit

- To prevent damage to the door gasket, the door must be opened all the way before pulling shelves out.
- The appliance must be positioned so that the plug is accessible.
- Empty your unit before attempting to move the appliance. Moving while loaded may damage or distort the frame.
- The compressor will get HOT during operation / touching it may cause injury.
- During installation follow all safety tips provided in this manual / appropriate safety equipment such as safety glasses and work gloves should be worn.
- Two people should move or lift your unit to prevent injury or damage.
- Remove all interior and exterior packing materials prior to installation and dispose of properly.
- Never cover the bottle racks with foil or other material which will impede internal air circulation.
- For maximum efficiency, keep the door tightly shut unless loading or unloading and never overload your unit.
- Before installing, allow your unit to sit upright for 2 hours at the install site. This will allow the cooling system to stabilize after transportation. Failure to follow this step may cause problems.
- Never store perishable food products such as meat or cheese in your wine cooler or beverage center.

## Location

- Your unit should be located away from direct sunlight and heat sources (stove, heaters, etc.) which may increase electrical consumption. High or low ambient temperature may cause units to work improperly.
- The floor must be strong enough to support your unit fully loaded.
- Your unit must not be installed in areas of where water or excessive moisture are present.
- Your unit must not be installed near where flammable, corrosive or hazardous materials are present.
- Your unit's final installation must observe the correct minimum air clearances around and behind the unit to ensure adequate ventilation. In addition, all ventilation openings must be kept clear and free of obstructions, failure to do so will result in damage to the unit.

## WARNING

NEVER use external heat sources to accelerate defrosting

NEVER permit unauthorized service or modifications to your unit

NEVER tamper with the sealed refrigerant system - this unit uses R600A Refrigerant which is flammable.

It should never be used in the vicinity of any flammable or explosive ignition sources.

ALWAYS FOLLOW THE ELECTRICAL SAFETY INSTRUCTIONS OUTLINED IN THIS MANUAL.

# ELECTRICITY - THIS IS SERIOUS

**Failure To Follow All Electrical Safety Measures May Result in Serious Injury, Fire Or Death**

- All electrical work should only be performed by an experienced, licensed electrician.
- All units **MUST** be grounded for safe operation and come equipped with a 3 Prong molded cord/plug for that purpose.
- **NEVER** remove or disable the 3rd prong with an adapter.



- **NEVER** use an extension cord to operate your unit.



- Your unit is built to operate on 115V 60Hz and should be plugged directly into a dedicated 15 amp 3 prong outlet. If you are uncertain as to the voltage, amperage capacity or if the 3rd prong is properly grounded - consult a licensed electrician.
- To maximize the depth of the installation recess - your outlet should be mounted flush with the wall.
- Your unit should not share the circuit with any other electrical devices as this may cause overloading, overheating, blown fuses or tripping circuit breakers. In a worst case this can pose a fire hazard.
- **NEVER** handle your unit in wet conditions as this can pose a severe danger of electric shock.
- Exercise care when moving your unit to avoid damage to the electrical cord. If the electrical cord of your unit becomes worn or damaged it must be replaced immediately by a qualified technician.
- **NEVER** unplug your unit by pulling on the cord. Unplug by gripping the plug firmly and pull out straight from the outlet.

## **INDOOR USE ONLY:**

This model is intended for indoor/interior applications only and is not to be used in installations that are open/exposed to natural elements.

This unit is designed to operate between 60°F and 90°F. Higher ambient temperatures may reduce the unit's ability to reach low temperatures and/or reduce performance.

For best performance, keep the unit out of direct sunlight and away from heat generating equipment. In climates where high humidity and dew points are present, condensation may appear on outside surfaces, particularly in non air conditioned spaces. This is considered normal. The condensation will evaporate when the humidity drops.

## **CAUTION**

Damages caused by ambient extremes are not covered by the warranty

**SERVICE 115V - 60 Hz - 1 phase**

**AMPS 15 Amp Circuit Breaker**

**Requires a Dedicated Outlet**

**All electrical work must be performed by a licensed electrician**

## **State of California Proposition 65 Warning(US only)**

### **⚠ WARNING**

This product contains chemicals known to the State of California to cause cancer and birth defects or other reproductive harm.

For more information go to [www.P65Warnings.ca.gov](http://www.P65Warnings.ca.gov)

# INSTALLATION OF YOUR UNIT

USE FREE STANDING - OR - INSTALL UNDER COUNTER

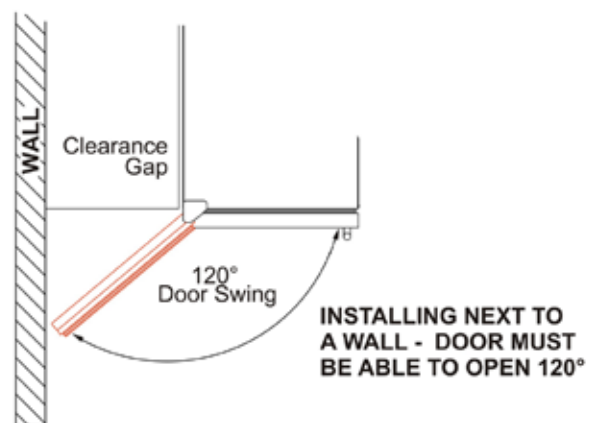
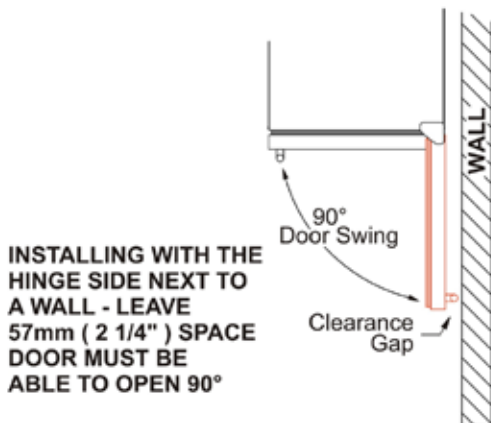
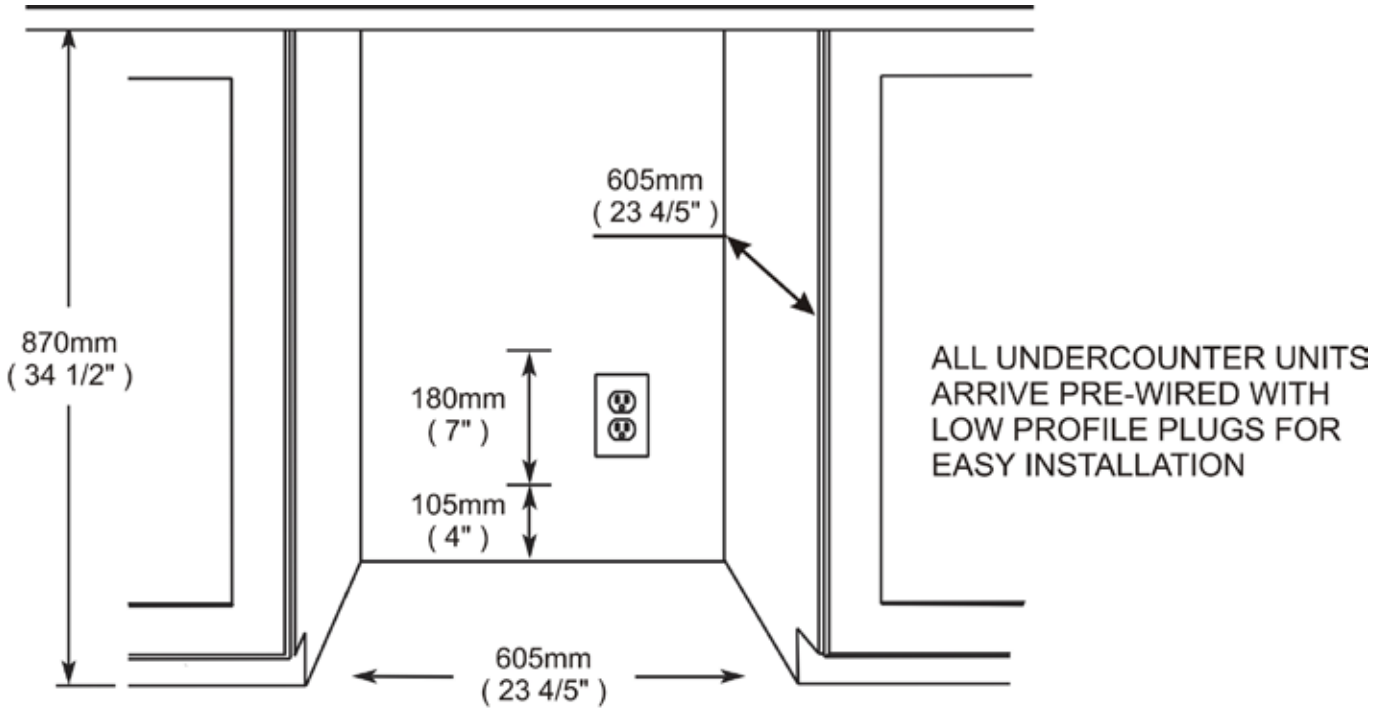

**IF THE DOOR CAN'T OPEN FULLY - YOU CAN'T PULL THE SHELVES OUT.**

If you need a little more space when installing - you might use a recessed outlet or cut the adjoining cabinet wall to reach an outlet there...

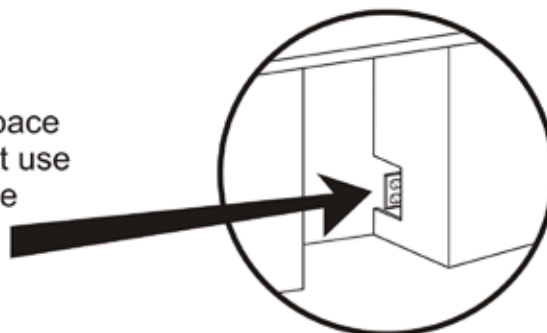

# INSTALLATION OF YOUR UNIT

## WIDTH & HEIGHT

VBWC5401S

VBWC5201D

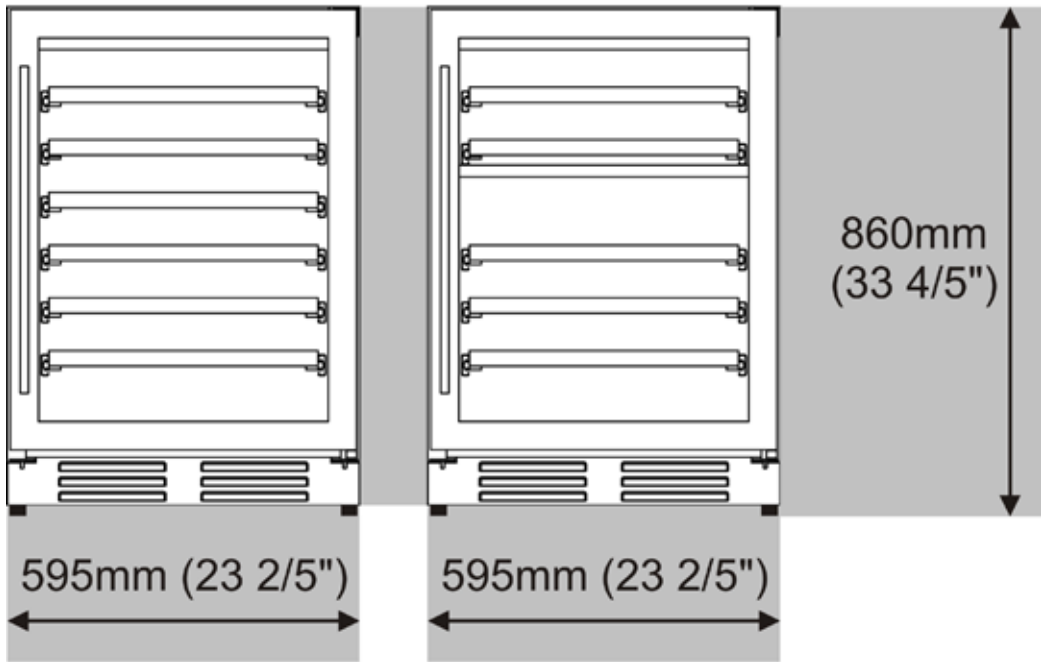

## DEPTH

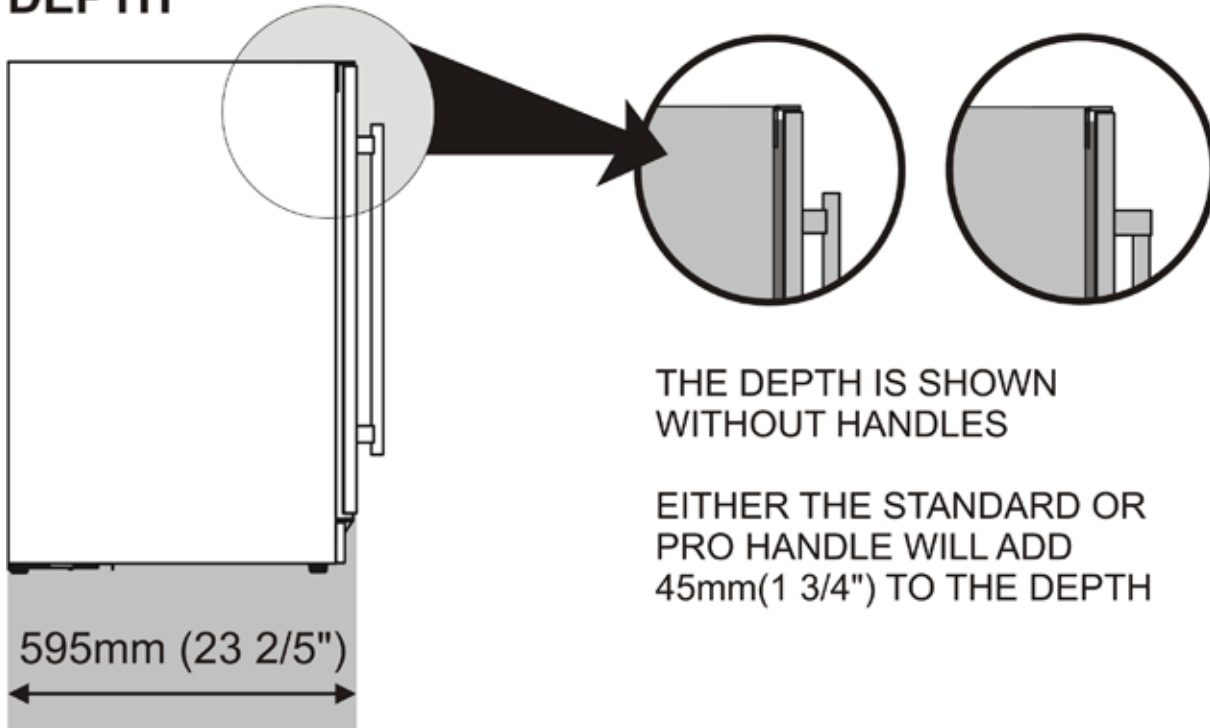

# INSTALLATION OF YOUR UNIT

DO NOT NEGLECT THIS IMPORTANT STEP

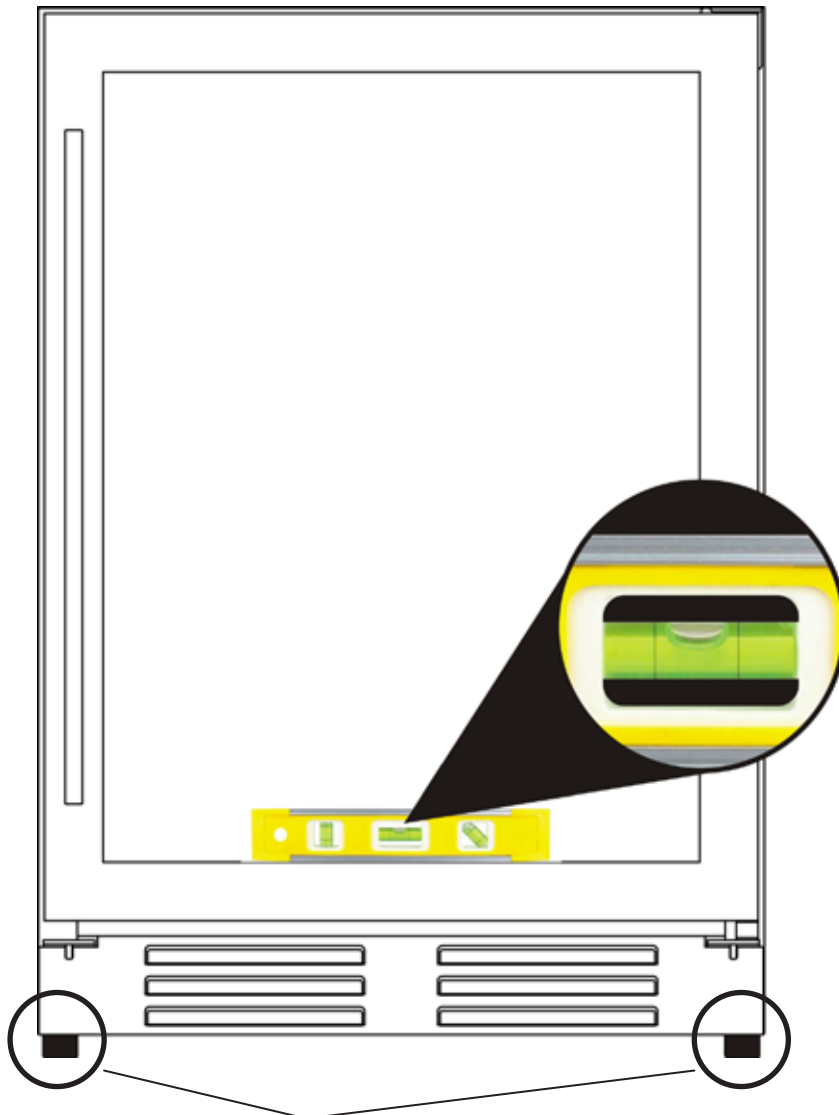

Rotate to raise or lower the **LEVELING LEGS** located at each of the four corners until all four legs are seated firmly on the floor and the interior floor of the unit is level both front to back and side to side.

Failure to follow this important step may cause problems with proper door operation, excessive condensation, vibration and noise.



# INSTALL THE DOOR HANDLE

Place the handle (B) over the 2 mounting studs (A) on the door frame with the set screws (C) pointing down.

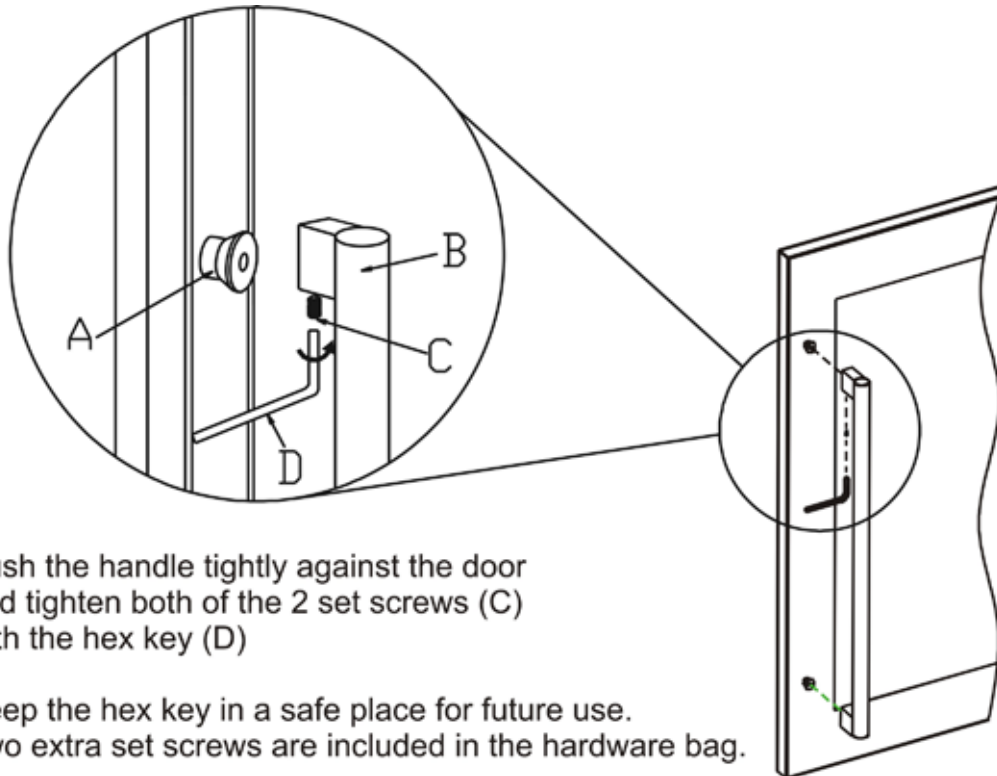

Push the handle tightly against the door and tighten both of the 2 set screws (C) with the hex key (D)

Keep the hex key in a safe place for future use.  
Two extra set screws are included in the hardware bag.

# HOW TO PUT OFF THE SHELVES

1. Take out the wine bottles from the shelves.
2. Please keep the door opened fully all the way before pulling the shelves out.
3. Touch the plastic buckles in the left and right of the sliding rail, pressing the left plastic buckle upwardly and pressing the right plastic buckle downward at the same time, and then pushing out the shelf.

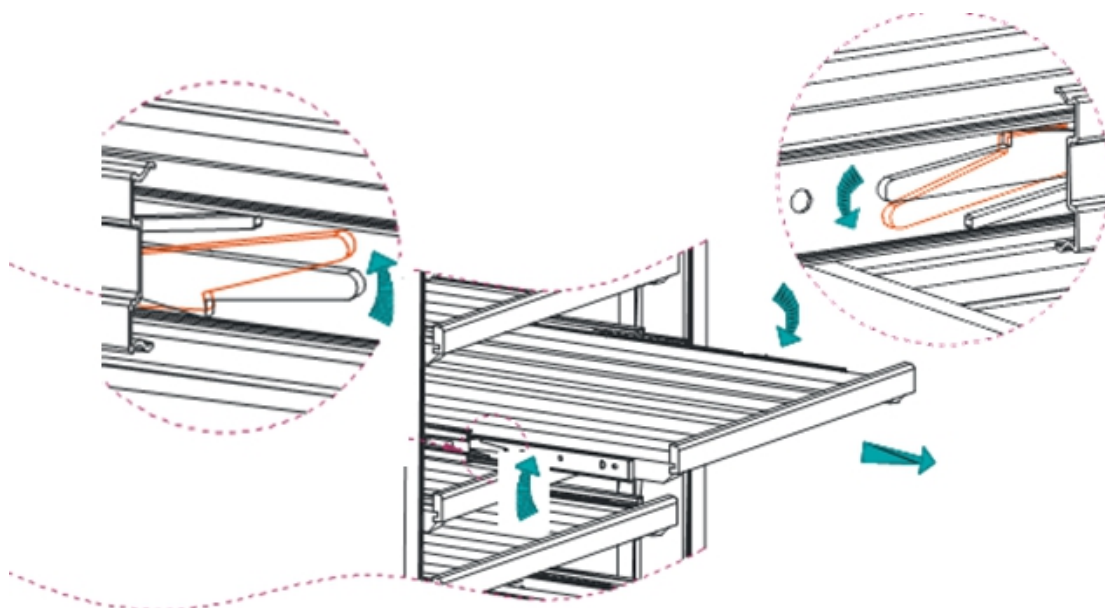

# REVERSING THE DOOR SWING

This appliance has the capability of the door opening from either the left or right side. The unit is delivered to you with the door opening from the left side. Should you desire to reverse the opening direction, please follow the instructions below:

1. Carefully lay the appliance on its back. Use cushioning to protect the floor and appliance.
2. Using a Philips screwdriver, remove the two screws and bottom right hinge beneath the door. Keep the hinge in a safe place in case you need to reverse the door again in the future.
3. Carefully slide the door off and place it on a padded surface.
4. Remove the bottom support bracket from the right side.
5. Remove the top right hinge and keep in a safe place in case you want to reverse the door in the future.
6. Remove the screws from the top left and transfer to the right.
7. Install the top left hinge.
8. Install the bottom left hinge to the door. Do not over-tighten the screw.
9. Rotate the door 180° and relocate it on the top hinge.
10. Install the bottom support bracket.
11. Adjust door alignment. When set, tighten screw on hinge.







**Please note:** Keep the spare hinge plate(s) to be able to reverse the door back again.

# OPERATING YOUR UNIT

For Model: VBWC5401S





## Setting the temperature Control

- Adjustable temperature: 1°C to 18°C (34°F to 65°F)
- Set the desired temperature by pressing the corresponding buttons,  to increase or  to decrease. Each press is in 1-degree increment. Once released, set temperature will flash for approximately 5 seconds then revert back to display the internal temperature.
- To view your set temperature, press either the  or  button once and LED display will flash set temperature for 5 seconds.
- The appliance has the capability to display temperature in either Celsius or Fahrenheit. To change the temperature scale, press and hold both   buttons simultaneously for approx. 3 seconds.

**Note:** The temperature inside may vary slightly depending on whether or not the interior bulb is ON or OFF and where the bottles are located (upper/middle or lower section).

### ECO mode:

- Press and hold the button  for 3 seconds, it can enter or exit ECO mode.
- In this mode, the interior LED light, the compressor indicator  and the temperature value on the display panel will be turned off and the ° will illuminate on the upper left corner of °C / °F.

### Light / Lock

- LED lamp brightness mode: with Memory IC (when unit restarts after power failure unit will auto recover at last setting), the default brightness is 100%.

Each time the button  is pressed, the brightness of the LED will be cycled from the four positions (100%, 75%, 50%, OFF)

- Press and hold for 3 seconds to lock or unlock the control panel.

### ON/OFF Power / Mute

- To turn the appliance on or off, press and hold the ON/OFF button for 3 seconds.
- When the high temperature alarm or low temperature alarm activated, the buzzer will sound continuously. Press  one time alarm will be closed.



## LOCK

If illuminated, indicates the control panel is locked.

## RUN



When unit's compressor is running, this indicator light will illuminate to signify that cooling mode is currently in operation.

### **Demo mode**

- Press and hold buttons ,  and  simultaneously for 10 seconds, it can enter or exit demo mode.
- In this mode, the display panel can operate settings, but the temperature is fixed display 12°C (54°F), all fans, the compressor does not start.

### **Defrosting**

- The unit defrosts automatically in normal operating conditions.
- The evaporator behind the rear wall of the unit defrosts automatically. Water will drain through the drain pipe from the back of the product. Users need to bring the water to the drain or find a appliance to load the water. (If loading with a appliance, you need to pay attention to clearing the water regularly).
- However, frost may accumulate on the evaporator if the unit is repeatedly opened in a high heat or high humidity location. If this frost pattern does not clear within 24 hours, your unit will require manual defrosting.

**Mandatory defrost mode:** Press the  and  at one time for 10 seconds, enter the compulsory defrost mode.

## For Model: VBWC5201D

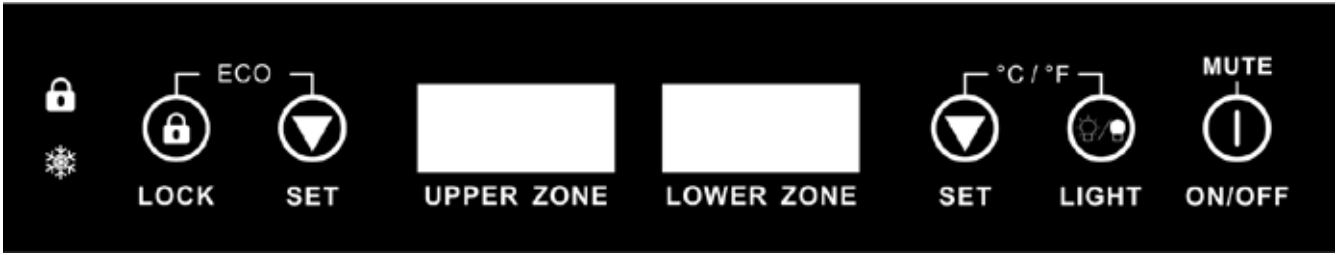



### LOCK

- Press and hold for 3 seconds to lock or unlock the control panel.
- If illuminated, indicates the control panel is locked.

### RUN



When unit's compressor is running, this indicator light will illuminate to signify that cooling mode is currently in operation.

### Setting the temperature Control

- Upper zone adjustable temperature: 5°C to 10°C (40°F to 50°F)  
Lower zone adjustable temperature: 10°C to 18°C (50°F to 64°F)  
**Please note:** For optimal performance, the difference of temperatures set in the two zones should be within the range 4~8°C
- Set the desired temperature by pressing the corresponding buttons, Left  or right  to decrease. Each press is in 1-degree increment. Once released, set temperature will flash for approximately 5 seconds then revert back to display the internal temperature.
- To view your set temperature, press either the  button once and LED display will flash set temperature for 5 seconds.

**Note:** The temperature inside may vary slightly depending on whether or not the interior bulb is ON or OFF and where the bottles are located (upper/middle or lower section).

### ECO mode:

- Press and hold the button   for 3 seconds to enter or exit ECO mode.
- In this mode, the interior LED light, the compressor indicator  and the temperature value on the display panel will be turned off and the symbol ° will illuminate on the upper left corner of °C / °F.

### Light

- LED lamp brightness mode: with Memory IC (when unit restarts after power failure unit, will auto recover to last setting), the default brightness is 100%.

Each time the button  is pressed, the brightness of the LED will be cycled through the four positions (100%, 75%, 50%, OFF)



## Temperature Conversion

The appliance has the capability to display temperature in either Celsius or Fahrenheit. To change the temperature scale, press and hold both   buttons simultaneously for approx. 3 seconds.

## ON/OFF Power / Mute



- To turn the appliance on or off, press and hold the ON/OFF button for 3 seconds.
- When the high/low temperature alarm is activated, the buzzer will sound continuously. Press  one time to turn off the alarm.

## Demo mode

- Press and hold three buttons , Left  and Right  simultaneously for 10 seconds to enter or exit demo mode.
- In this mode, the display panel can operate settings, but the temperature is a fixed display 12°C (54°F) and all fans plus the compressor will not start.

## Defrosting

- The unit defrosts automatically in normal operating conditions.
- The evaporator behind the rear wall of the unit defrosts automatically. Water will drain through the drain pipe from the back of the product. Users need to bring the water to the drain or find an appliance to load the water. (If loading with an appliance, you need to pay attention to clearing the water regularly)
- However, frost may accumulate on the evaporator if the unit is repeatedly opened in a high heat or high humidity location. If this frost pattern does not clear within 24 hours, your unit will require manual defrosting.

**Mandatory defrost mode:** Press the  and  at one time for 10 seconds to enter the compulsory defrost mode.

## NOTE:

- If the unit is unplugged or turned off, or if there has been a power failure, you must wait 5 minutes before restarting the unit. If you attempt to restart before this time delay, the appliance will not start.
- When you use the appliance for the first time, or restart it after it has been shut off for a long time, there could be a few degrees variance between the temperature you select and the one indicated on the display. This is normal and due to the length of inactivation time. Once the appliance has been running for a few hours, everything will be back to normal.

### **Temperature Alarm Function**

If the ambient temperature  $\geq 30^{\circ}\text{C}$  ( $86^{\circ}\text{F}$ ) for 2 hours, the high temperature alarm will be activated, the LED will display "HH", the buzzer will sound continuously, the cooling system continues to work. The display return to normal until the high temperature conditions is relieved.

If the ambient temperature is  $< 0^{\circ}\text{C}$  ( $32^{\circ}\text{F}$ ) for 1 hour, the low temperature alarm will be activated, the LED will display "LL", the buzzer will sound continuously, the cooling system will stop working. The display return to normal until the low temperature is relieved.

#### **NOTE:**

- It is normal that the cabinet shows "HH" or "LL" from time to time. If it occurs frequently or lasts for a long time, you can restart the unit by unplugging it, then re-plugging after 5 minutes. If the problem occurs again after restarting, please contact customer service.
- Before reconnecting the power, wait 3 to 5 minutes. Otherwise you could damage your appliance. If you attempt to start the appliance before the end of this time delay, the appliance will not turn on.
- If you turn on the appliance for the first time or after a restart, or after it has been out of operation for a long time, there may be a temperature difference between the temperature inside the appliance and that on the LED display. This is a normal event caused by the duration of the activation period. Leave the appliance turned on for several hours and the temperatures will stabilize during operation.

# A BREATHE OF FRESH AIR

FOR BEST RESULTS CHANGE EVERY 3 TO 6 MONTHS

Your Air Refresh  
Charcoal Filter  
Is Located Here

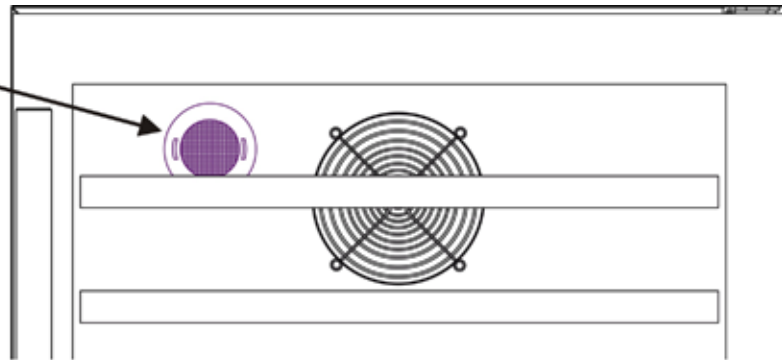

Rotate the filter 1/4 turn  
to unlock

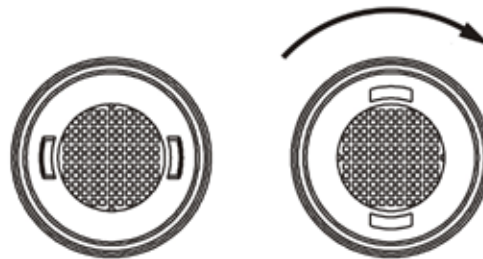

Pull straight out to remove  
Align the tabs and  
insert the new filter

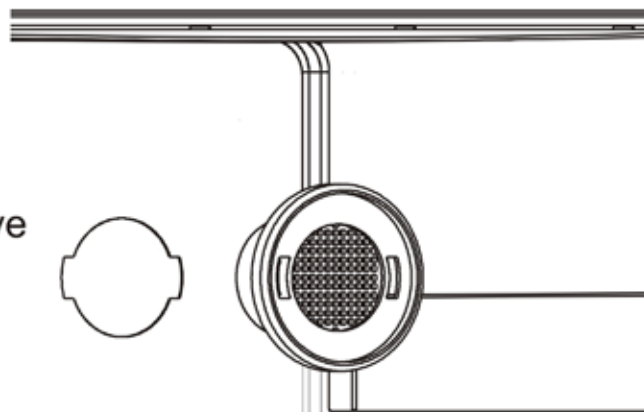

Rotate filter 1/4 turn  
to lock in place

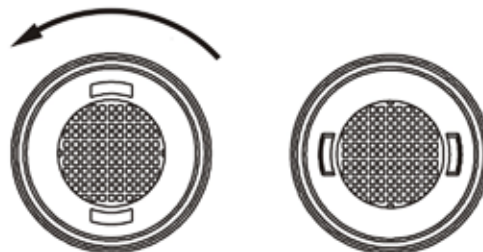



# CARE AND MAINTENANCE

## **Cleaning Your Appliance**

1. Turn off the power, unplug the appliance, and remove all items.
2. Wash the inside surfaces with a warm water and baking soda solution. The solution should consist of about 2 tablespoons of baking soda to a quart of water.
3. Wring excess water out of the sponge or cloth when cleaning the area of the controls or any electrical parts.
4. Wash the exterior of the cooler with a warm solution of mild liquid detergent. Rinse well and wipe dry with a clean soft cloth.

## **Power Failure**

Most power failures are corrected within a few hours. If your power is going to be off for a longer period of time, you need to take the proper steps to protect your contents.

## **Transporting Your Appliance**

If you need to move your appliance once the box has been discarded:

1. Securely tape down all loose items inside your appliance.
2. Turn the adjustable legs up to the base to avoid damage.
3. Be sure the appliance stays secure in the upright position during transportation. Also protect the outside of the appliance with a blanket or similar item.

## **Energy-Saving Tip**

The appliance should be located in the coolest area of the room, away from heat-producing appliances and out of direct sunlight.

# PROBLEMS WITH YOUR APPLIANCE

You can solve many common problems easily, saving you the cost of a possible service call. Try the suggestions below to see if you can solve the problem before calling the servicer.

## TROUBLESHOOTING GUIDE

PROBLEM	POSSIBLE CAUSE	REMEDY
Appliance does not operate.	<ul style="list-style-type: none"> <li>The unit defrosts automatically in normal operating conditions.</li> <li>The appliance is turned off.</li> <li>Tripped circuit breaker or a blown fuse.</li> </ul>	<ul style="list-style-type: none"> <li>Connect the appliance.</li> <li>Switch on the appliance.</li> <li>Switch on the circuit breaker or replace the fuse.</li> </ul>
Appliance is not cold enough.	<ul style="list-style-type: none"> <li>The temperature is not set correctly.</li> <li>The ambient temperature could require a lower temperature setting.</li> <li>The condenser is too dirty.</li> <li>The ventilation opening is blocked or too dusty.</li> </ul>	<ul style="list-style-type: none"> <li>Check the set temperature.</li> <li>Set a lower temperature.</li> <li>Clean the condenser when necessary.</li> <li>Clear the obstructions and wipe off the dust.</li> </ul>
Appliance turns itself on and off frequently.	<ul style="list-style-type: none"> <li>The room temperature is higher than average.</li> <li>A large number of bottles has been added to the unit.</li> </ul>	<ul style="list-style-type: none"> <li>Put the appliance in a cooler place.</li> <li>Leave the appliance to work for a while until the set temperature has been reached.</li> </ul>
The light does not work.	<ul style="list-style-type: none"> <li>Appliance is not connected to a power supply.</li> <li>Tripped circuit breaker or a blown fuse.</li> <li>The light was switched off on the control panel.</li> </ul>	<ul style="list-style-type: none"> <li>Connect the appliance.</li> <li>Switch on the circuit breaker or replace the fuse.</li> <li>Switch on the light.</li> </ul>
Vibrations	<ul style="list-style-type: none"> <li>The appliance is not properly level.</li> </ul>	<ul style="list-style-type: none"> <li>Level the appliance with the adjustable feet.</li> </ul>
The appliance seems to make too much noise.	The rattling noise may come from the flow of the refrigerant, which is normal. As each cycle ends, you may hear gurgling sounds caused by the flow of refrigerant in your appliance. If temperature fluctuations occur, the contraction and expansion of the inner walls may cause popping and crackling noises.	
	<ul style="list-style-type: none"> <li>The appliance is not properly level.</li> </ul>	<ul style="list-style-type: none"> <li>Level the appliance with the adjustable feet.</li> </ul>
Display “E1”, “E2”.	<ul style="list-style-type: none"> <li>“E1” or “E2” indicates that the air temperature sensor has failed.</li> </ul>	<ul style="list-style-type: none"> <li>Call for service.</li> </ul>

*NOTE: This appliance is intended to be used exclusively for the storage and display of wines in restaurants, hotels, bars and other commercial settings.*